ROBOTIC VACUUM CLEANER

MODEL NO.:HOVO620

USER MANUAL

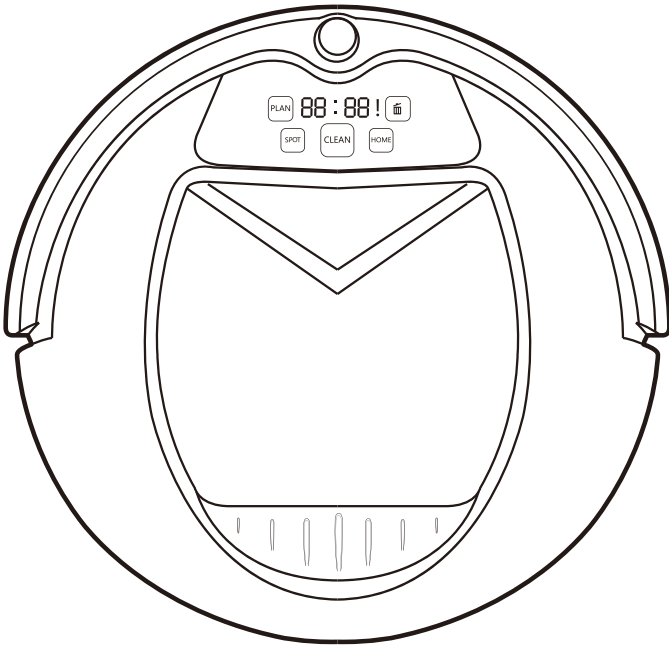

Table of Contents

Safety Instrucions	1
Product Features	2
Product Illustrations	3-7
Main unit and acceccories	3
Main Unit and Dust Bin	4
Charging Station and Virtual Blocker	5
Remote Control Unit	6
Unit Display Panel	7
Product Operations	8-11
Battery Charging Methods	8
Cleaner Operations	9
Schedule Cleaning Time	10
Cleaner Operations	11
Virtual Blocker Usage	11
Product Maintenance	12-13
Clean Side Brushes	12
Clean Dust Bin and Filters	12
Clean Sensors	13
Assembly & Disassembly The Mop	13
Troubleshooting	14-16
Error Codes Chart	14
Replaceable Modules	15
Battery Installation and Replacement	16
Unit Usage Limitation	16
Product Specification	17

Safety Instructions

Before using this product, please read the following safety instructions and follow all normal safety precautions.

! Read this user manual thoroughly and carefully before using this product.

! Save this user manual.

! Follow these precautions to reduce the risk of injury or damage.

WARNING

- 1** Only a certified technician can disassemble and/or repair the product.
- 2** Only use the adapter provided by the factory. Using other non-authorized adapter may cause electric shock, fire or product damage.
- 3** Do not touch the power cord, plug or adapter when your hands are wet.
- 4** Do not make clothes or part of a body drawn into the product's wheels.
- 5** Do not use product near any flammables.
- 6** Do not clean while product is charging.
- 7** Do not over bend or put large weight on the power cord.
- 8** This product is for indoor use and clean dry surface floor only.
- 9** Do not sit on top of this product or attach an object on the top of it.
- 10** Do not use this product in wet or moist environment (any environment with liquid).
- 11** Before use, remove damagable objects (glass, textiles, papers, etc.) that can get caught in the cleaner's brush or vacuum intake.
- 12** Do no place this product where it is easy to drop off (tables, chairs, etc).
- 13** Turn off the power switch during transportation or when you don't need to use this product for a long time.
- 14** Before charge battery, make sure that the adapter and outlet are properly connected in right sequence to avoid sparks.
- 15** To avoid injury; inform all people in the house that the unit is doing cleaning.
- 16** Do not use this product when dust bin is full.
- 17** Use this product in temperatures between 0°C and 40°C (32°F and 104°F).
- 18** Do not place this product in high-temperature environment.
- 19** Remove battery from unit before recycle or scrap unit.
- 20** Disconnect AC adapter before removing the battery.
- 21** The battery should be properly disposed.

NOTE: Do not allow children to operate this product unless they are supervised by an adult

Product Features

Powerful Suction & Intelligent Suction Adjustment

Powerful suction

Suction power of this product reaches 25 W, ensuring that even tiny dust on the floor will be cleaned thoroughly.

Intelligent Suction Adjustment

This product will adjust its suction power according to the different floor types. It will clean the floor more effectively and also save power consumption.

User Friendly Design

Easy operation

Voice message guidance and touch screen operations.
Just touch CLEAN key to start cleaning floor.

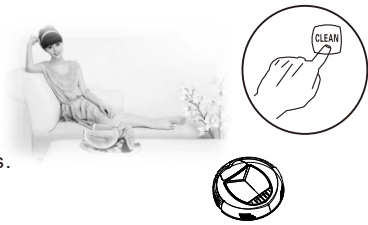

Wash Dust Bin

Empty and wash dust bin with water regularly for cleaning effectiveness.

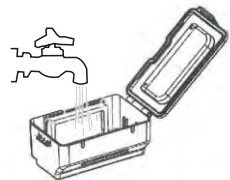

Four Cleaning Modes

Four cleaning modes are provided to meet your needs.

1. Auto cleaning mode

The cleaner will clean and vacuum the floor automatically and adjust its cleaning routine based on its environment.

2. Spot cleaning mode

The cleaner will spend more time to clean dirty areas.

3. Edge cleaning mode

The cleaner will clean the edge and corner of walls.

4. Scheduling mode

You can schedule the cleaner to start cleaning at pre-defined time.

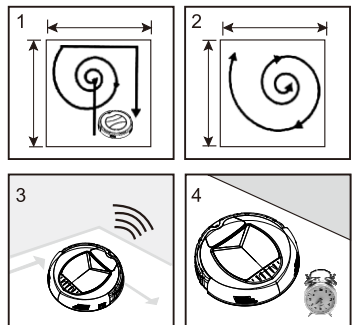

Product Parts

Main unit and accessories

No.	Description	Q'ty
1	Main Unit	1
2	Self Charging Base	1
3	Remote Control(battery included)	1
4	Virtual Blocker (battery not included)	1
5	AC Adapter	1
6	Cleaning Brush Tool	1
7	Mop	1
8	Spare Side Brushes	2
9	HEPA Filter	1
10	User Manual	1

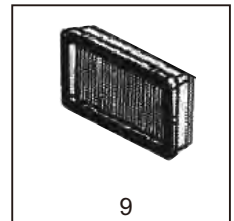
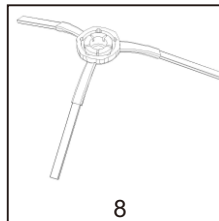
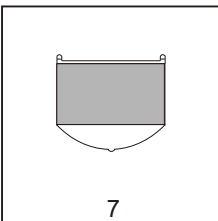
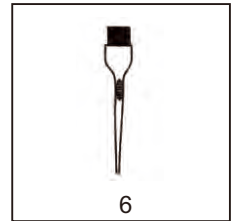
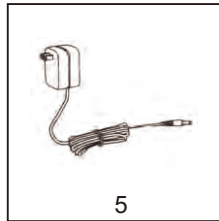
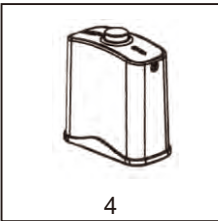
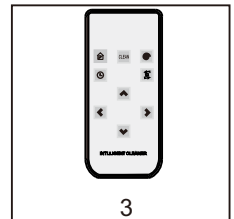
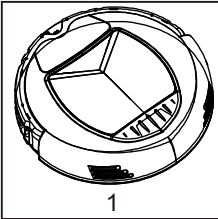

Product Parts

Main Unit and Dust Bin

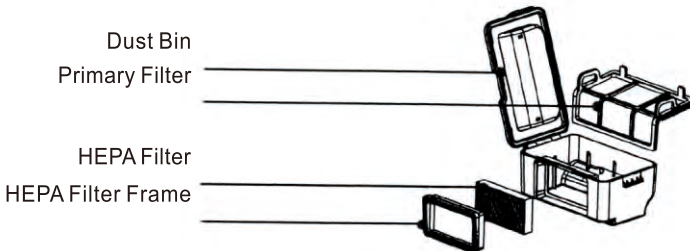
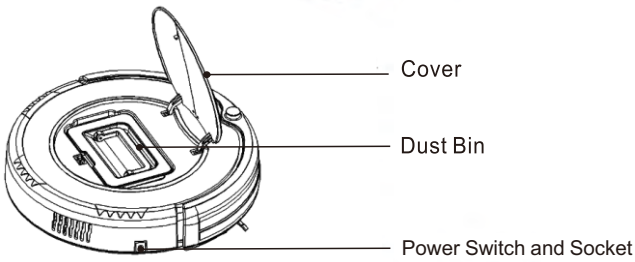
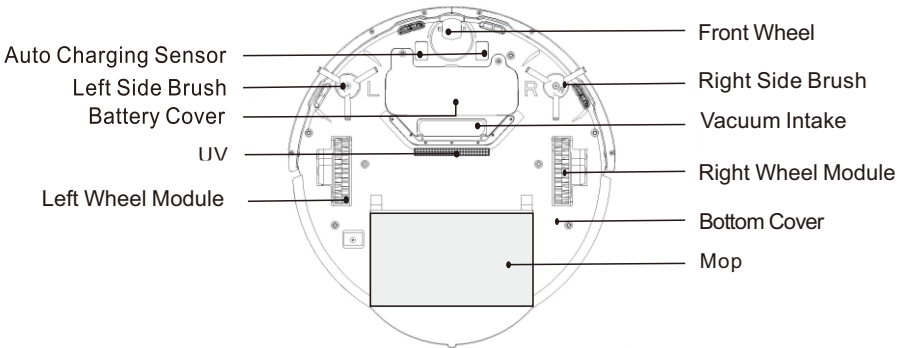
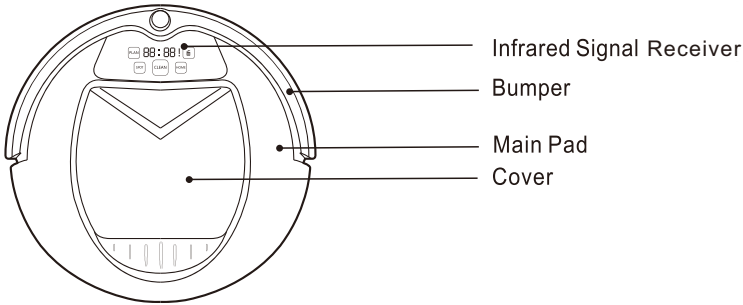

Product Parts

Charging Station and Virtual Blocker

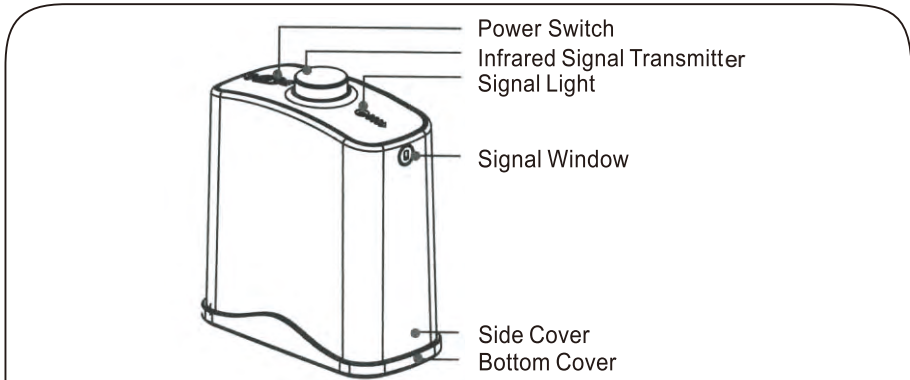
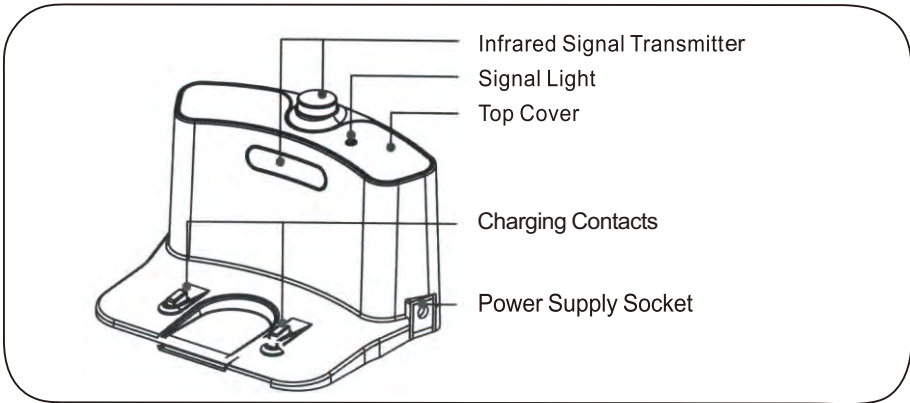

Installing virtual blocker battery

<p>1</p> <p>Lift the cover of the virtual blocker.</p>	<p>2</p> <p>Install two D type batteries into the virtual blocker as shown;</p>	<p>3</p> <p>After inserting the tip of the cover into the slot, push the other end to close it until it clicks into place.</p>
--	---	--

Note: Take out the batteries if you won't use virtual blocker for long period of time.

Product Parts

Remote Control Unit

- 1 "🏠" Home button
- 2 "🕒" Scheduling button
- 3 "🎯" Spot button
- 4 "⬅️➡️" Directional Buttons
- 5 "🧹" Clean/Power button
- 6 "👉" Edge button

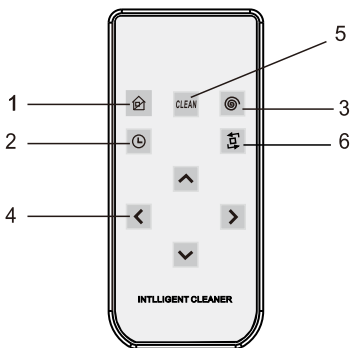

Use the remote control to wirelessly control the cleaner unit. Make sure the unit is switched on before using the remote. Point the remote towards the unit and press button to control unit operation.



Install one coin type battery into remote control unit.

Do not use remote near self charging base or virtual blocker.

Product Parts

Unit Display Panel Illustration

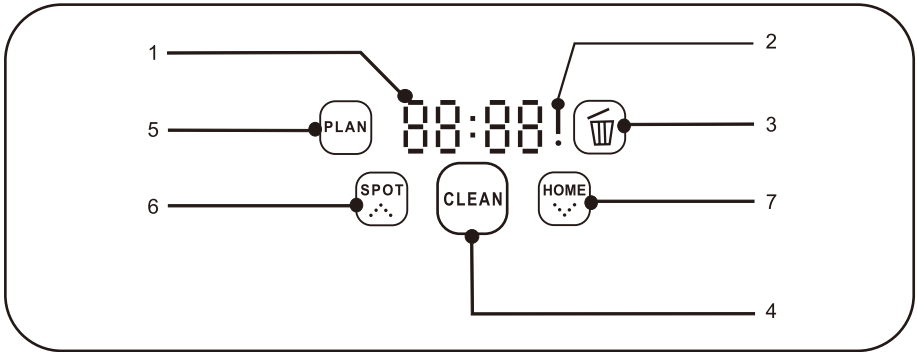

Display Illustration

- 1 “88:88” numeric display: Shows timer, unit status, battery charging status, and error codes.
- 2 “ ! ” display: Shows an error has occurred.
- 3 “ 🗑 ” display: Flashes constantly when dust bin is full or when vacuum intake is blocked.

Control Button

- 4 “ CLEAN ” Clean: Press “ CLEAN ” to complete following operations:
 - A. To change from sleeping mode to selected mode; pressing this button to change from selected mode to sleeping mode.
 - B. To confirm scheduling in scheduling mode.
 - C. To start cleaning in selected mode.
- 5 “ PLAN ” Scheduling
 - A. Press “ PLAN ” to enter scheduling mode.
 - B. Press this button to switch between hour and minute in scheduling mode.
 - C. Keep pressing this button for 5 seconds to cancel scheduling in scheduling mode.
- 6 “ SPOT ” Spot: Press “ SPOT ” to complete following operations:
 - A. Press this button to increase number in scheduling mode.
 - B. When cleaner is in selected mode press this button to make cleaner start spot cleaning
- 7 “ HOME ” Home: Press “ HOME ” to complete following operations:
 - A. Press this button to decrease number in scheduling mode.
 - B. When cleaner is in selected mode, pressing “ HOME ” to return the cleaner to self charging base.

Product Operations

Battery Charging Methods

1 Place self charging base

Note: Put self charging base against the wall and remove obstacles about 3 ft at two sides and about 6 ft in front.

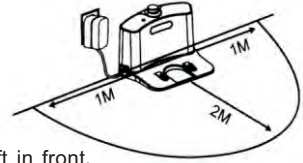

2 Turn on the Power Switch at the side of cleaner, then display will flash.

(If the unit does not receive a command for 20 seconds, it will go into Sleep mode.)

Note: A. Please keep the power switch on. If not, it will not operate.
B. If power switch is turned off; scheduling data will be erased.

Caution: Before charging the cleaner, please make sure the power switch is turned on; otherwise, the cleaner can not be charged.

3 Manual Charge Battery

A. Plug adapter power cord to unit power socket first and plug AC adapter to wall outlet next.
B. Connect charging base with AC adapter to wall outlet to power on, "Press HOME button on cleaner unit or remote control to make cleaner return to charging base."

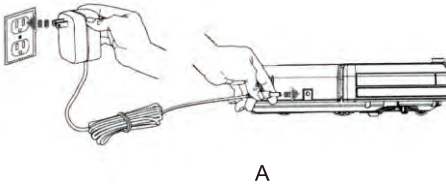

A

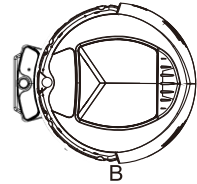

B

Note:

- A. Turn on power switch before start to charge cleaner battery.
- B. When the cleaner is charging, the display panel will show 1111, and repeat from right to left.
- C. Before first use, charge the robot for 12 hours. When charging is finished, the display panel will show FULL.
- D. Before first time use, let the cleaner do cleaning until the battery is used up.
- E. After the battery is used up, recharge the cleaner as soon as possible.
- F. If the cleaner is not used for a long time, please turn the power switch off.
- G. Do not operate the cleaner while it is charging.



4 Auto charging

The cleaner will automatically return to the self-charging base when cleaning is done or the battery is low.

Note: When the battery is low, the display panel will show "Lo".

Please keep the self-charging base plugged in; otherwise, the cleaner will not find the base to do auto battery charging.

Product Operations

Starting up/Pause/Sleeping

1 Starting up

- A. Make sure the power switch is on;
- B. Press CLEAN on the cleaner unit or remote control unit to start cleaning.

Note: If cleaner is in sleeping mode, press CLEAN button to wake up the cleaner.

The press CLEAN for a second time, the cleaner starts cleaning automatically.

2 Changing modes

Changing modes while unit is cleaning

- A. Press PLAN, CLEAN, or HOME on cleaner or CLEAN on remote control to pause the current mode.
- B. Select new mode you wish to use.

Note: When cleaner is paused, press CLEAN on cleaner or remote to resume cleaning.

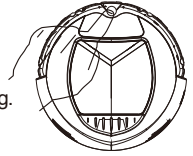

3 Sleep mode

To make cleaner go into sleep mode:

- A. Cleaner will go into sleep mode if it does not receive any commands for 20 seconds.
- B. Otherwise, press CLEAN on cleaner for 3 seconds

Note: Turn off the power switch if you are not using the cleaner for a long period of time.









Product Operations

Scheduling







You can schedule the cleaner to do cleaning at pre-defined time every day. There is no real time clock setting function. You can set schedule cleaning time hh:mm hours and minutes (delay time) from current time on your clock. Time delay can be set up to 24 hours. For example, it is 9:00AM on your clock, you set 6:30 delay time on the cleaner, and the cleaner will start cleaning after 6 hours and 30 minutes which is 3:30PM. The cleaner will start cleaning at 3:30PM every day until unit power switch is turned off.

How to set cleaning delay time (hh:mm)?

1 On cleaner unit

- A. Press “” to enter scheduling mode, the hours on “88:88” on LED display will flash.
- B. Press “” and “” to increase or decrease hours.
- C. Press “” to move from hours to minutes.
- D. Press “” and “” to increase or decrease minutes.
- E. Press “” to finish scheduling.
- F. To cancel scheduling, keep pressing “” for 5 seconds in scheduling mode and delay time will be erased.

2 On remote control unit

- A. Press “” to wake up cleaner unit, then press “”, the hours on “88:88” on LED display will flash.
- B. Press “” button to increase or decrease hours.
- C. Press “” or “” to move from hours to minutes.
- D. Press “” button to increase or decrease minutes.
- E. Press “” to finish scheduling.
- F. To cancel scheduling, set hours and minutes on LED display to “00:00” in scheduling mode.

Product Operations

Cleaning mode

1 Auto Cleaning Mode

The cleaner will clean the area and adjust its cleaning routine according to its environment.

Note: Press CLEAN on cleaner or remote to start auto cleaning mode

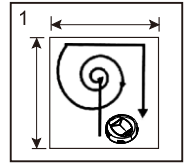

2 Spot Cleaning Mode

Place cleaner near dirty area. Press SPOT to start cleaning and press CLEAN to stop.

Note:

Spot cleaning makes the cleaner spend more time cleaning a dirty area.

Spot cleaning mode will stop once the area is clean.

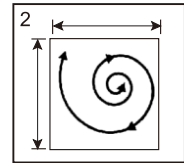

3 Edge Cleaning

When the cleaner detects an obstacle, it will use its side brushes to clean the sides

Note:

Place cleaner against a wall.

Press EDGE on remote unit to start edge cleaning mode; press CLEAN to stop.

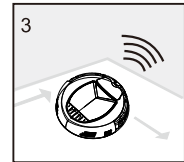

Virtual Blocker

Virtual Blocker creates an invisible barrier that the cleaner will not cross. The Virtual Blocker can be used to confine the cleaner in a room (put it outside the door way) or prevent it from going towards fragile objects. Virtual Blocker can block an opening of up to 4m (13 ft)

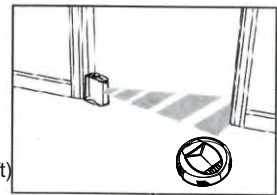

1 After batteries are installed, turn on the power switch.

2 Put the virtual blocker where you want it to work.

Note:

When using virtual blocker, put "  "side of virtual blocker towards the area you want to set.

Turn the power off when not using virtual blocker.

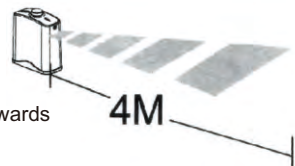

Product Maintenance

Clean Side Brushes

- A. Check side brushes for damage or foreign object on the brush.
- B. Clean the side brushes.
- C. ● Remove the screws of the side brushes
 - Replace brushes with new ones
 - Use screws to lock the new brushes in place

Note:

Make sure the "L" and "R" on the brush matches with the "L" and "R" on the cleaner.

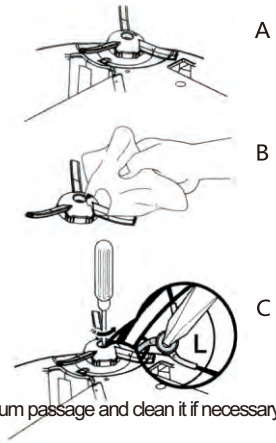

Clean dust bin and filter

Note: After taking out dust bin, check if there is foreign object stuck or block the vacuum passage and clean it if necessary.

- A. Press "PUSH" to open the dust bin cover.
- B. Take out the dust bin.
- C. Separate HEPA filter from dust bin.
- D. Pull out dust bin top cover and take out primary filter.
- E. Empty dust bin and wipe the dust.
- F. Wash dust bin with water. Clean filters with cleaning brush tool, DO NOT wash it with water.

Note: 1. Clean dust bin module when "⚡" and "!" icons are flashing on the display panel.

2. Do not wash HEPA filter and replace it after one year of usage.

- G. Install primary filter and HEPA filter into dust bin.

Note: 1. Install both HEPA and primary filters when they are dry.

2. Do not place HEPA and primary filters directly in the sun.

- H. Close dust bin cover and install it into main unit.

Note: Dust bin and filters (including HEPA and filter) could be replaced if needed.

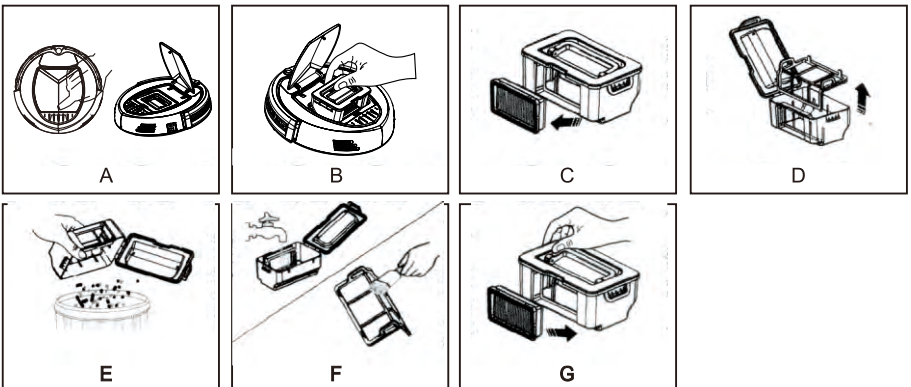

Product Maintaining

Clean Sensors

Wipe the sensor window and auto charging sensors with cleaning tool or a soft dry cloth.

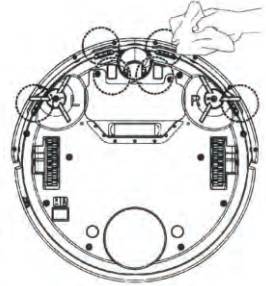

Clean charging contacts on self charging base.



Clean vacuum intake and dust sensor as shown in figure below.

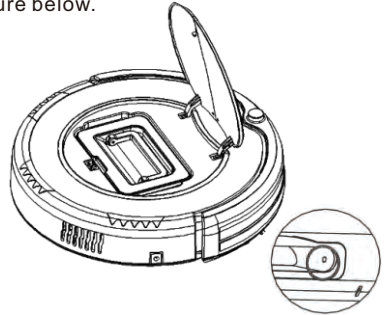

Note:

Never let water, thinner, etc directly touch the sensor window.

Assembly & Disassembly The Mop

Reverse the cleaner, tear out the mop , unplug the fastener at the bottom of the cleaner to release the trailing bar(refer to figure A and B). you can assemble it as before disassembly.

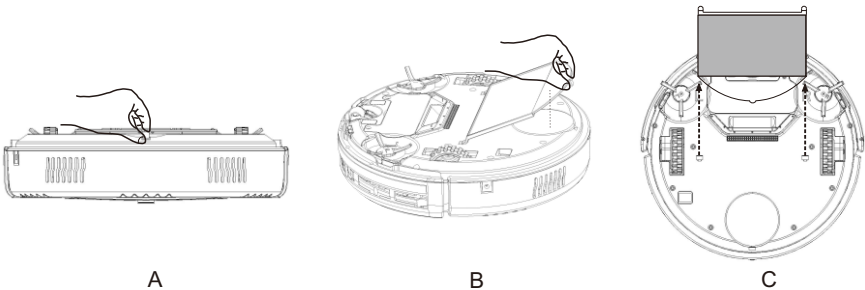

Don't use the mop and trailing bar on the carpet or uneven ground.

Troubleshooting

Error Codes Chart

Error code will show on display panel if there is a problem with the cleaner

Error Code	Cause	Solution
E01	Left wheel error	Remove hair and debris from the cleaner's left wheel. Push it in and out and check if the wheel can turn freely.
E02	Right wheel error	Remove hair and debris from the cleaner's right wheel. Push it in and out and check if the wheel can turn freely.
E03	Not in use	
E04	Unit is lifted up	Place cleaner on the floor
E05	Cliff sensor fail	Clean the cliff sensor with a cotton swabs
E06	Bumper sensor fail	Check bumper can move freely and is free from any debris
E07	Left brush error	Remove and clean left brush
E08	Right brush error	Remove and clean right brush
E09	Unit is stuck	Move main body and start again
 and ! flash	Dust bin full	Clean dust bin and vacuum intake

Note: If the error condition is not resolved, do the following:

1. Restart the cleaner by switching off and on power switch.
2. If restarting doesn't work, remove battery for more than 10 minutes to reset system.
3. If it is still not working, then contact your local service center for repair.

Troubleshooting

Replaceable modules

There are a number of modules that can be replaced.

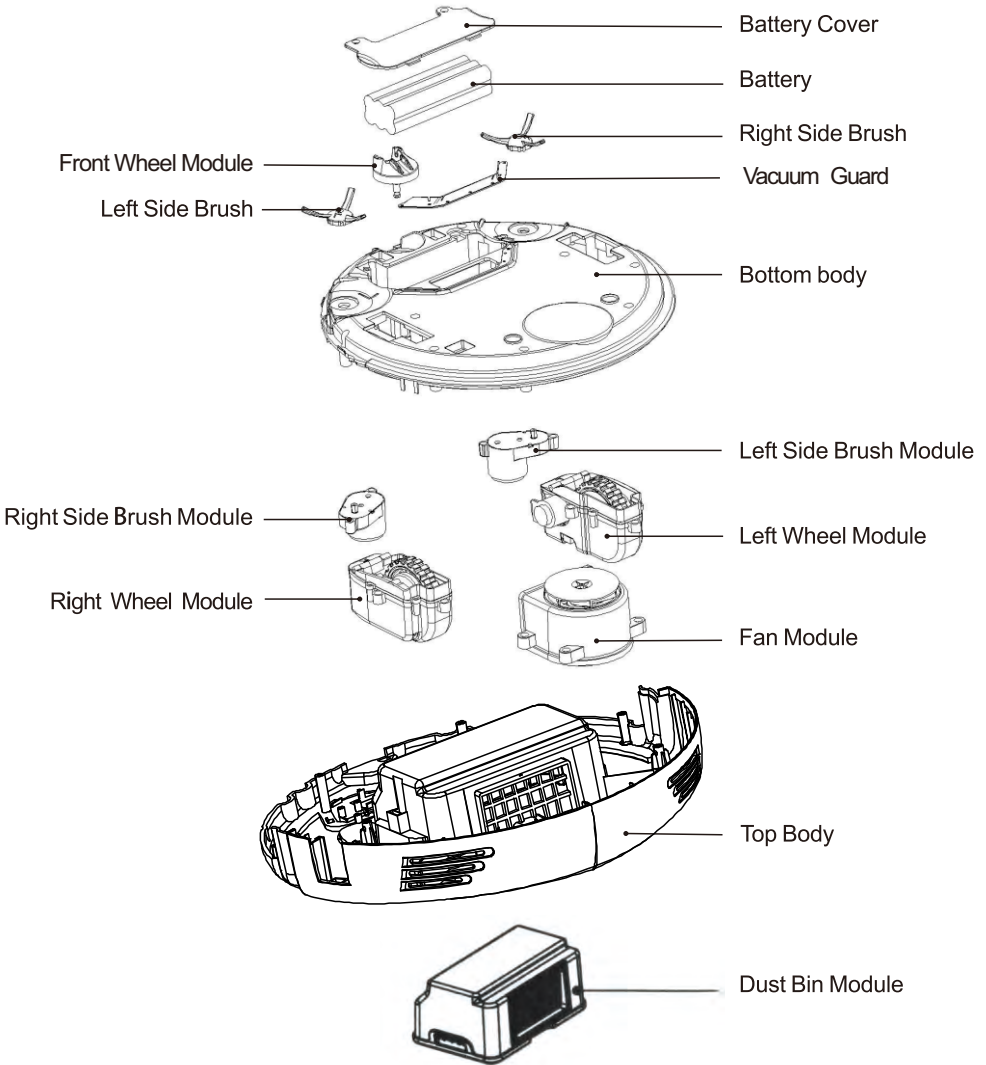

Troubleshooting

Battery Installation and Replacement

- A. Remove two screws from battery cover with screw driver
- B. Open the battery cover.
- C. Take out the battery using the 2 strip holder on its sides
- D. Disconnect the wire connector that connects the battery and unit.
- E. Put a new battery into battery slot with 2 strip holders face up
- F. Reconnect the wire between the battery and unit correctly.
- G. Make sure the wire connector is stored on the cavity.
- H. Put the battery cover back and make sure side brush is not stuck in.
- I. Lock back battery cover with screws.

Note: Only use factory authorized batteries

Unit Usage Limitation

The cleaner unit can **ONLY** be used at residential houses indoor and dry floor. It will clean the debris, dirt, dust, and pet hairs off the floor, and work well on hardwood, tile, linoleum, and low-pile (up to 0.5 inches) carpet.

Product Specifications

Classification	Item	Detail
Mechanical Specifications	Diameter	13.4" (340mm)
	Height	3.54" (90mm)
	Weight	6.6 Lbs (3. 0Kgs)
Battery Specifications	Power voltage	14.4 V
	Battery specifications	2000mAH
AC Adapter Specification	Input	100—240V 50/60Hz 0. 8A
	Output	24.0V/1.0A
Cleaning Specifications	Dust bin capacity	0.4Liters
	Charging type	Auto Charging/Manual Charging
	Cleaning mode	Auto, Spot, Edge, Daily Schedule
	Charging time	3 - 4 hours
	Cleaning time	About90min
Main Unit Button Type		Touch(LED display)

Metapo Inc.
<http://www.infinuvo.com>
<http://www.metapo.com>